

A. General Specifications

Maximum temperature rating (all zones):	350°C
Nominal operating temperature:	80-350°C
Number of controlled heated zones:	8 Top 8 Bottom
Oven atmosphere:	Air
Working dimensions:	
Conveyor belt	457 mm
Product clearance (standard). [Other clearances available]	50,8 mm (+30,5/-20,3)



B. Dimensional Layout



Description	mm
Entrance Onload Area	330,2
Lip Vent Exhaust	355,6
Zone 1	317,5
Zone 2	317,5
Zone 3	317,5
Zone 4	317,5
Zone 5	317,5
Zone 6	317,5
Zone 7	317,5
Zone 8	317,5
Total Heated Length	2540,0
Exit, Lip Vent Exhaust	304,8
Fan Cooling	610,0
Exit Offload Area	508,0
Total System Length	4648,6
<i>Total System Width</i>	<i>1524,0</i>
<i>Total System Height</i> <i>(Assumes 914 mm Hearth Line)</i>	<i>1524,0</i>

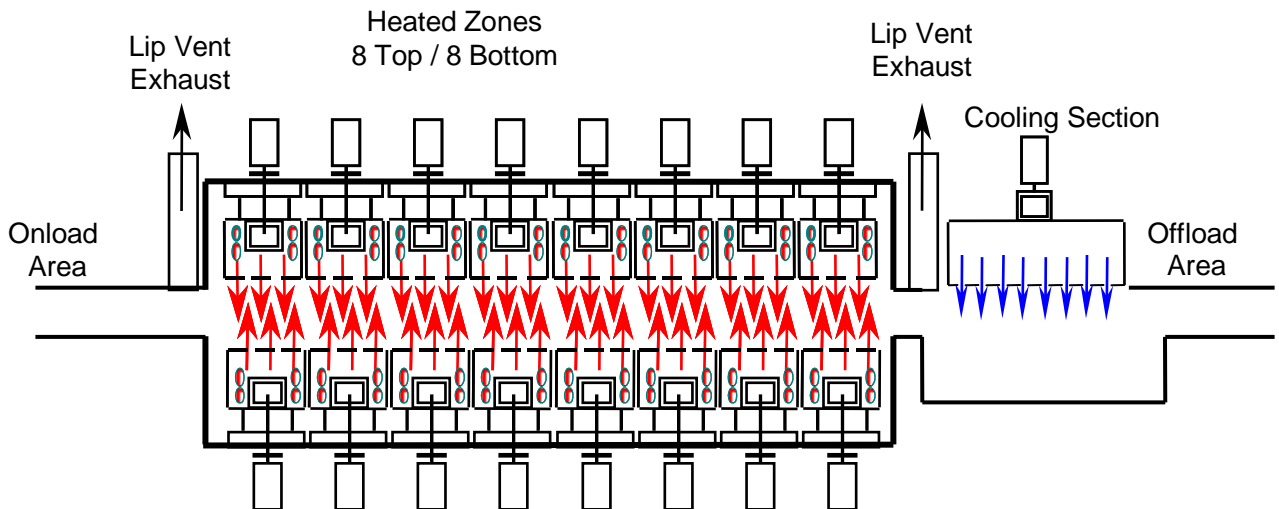

C. Process Chamber

Heating Section

- Heating is accomplished via *Forced Impingement Convection* with side to side gas recirculation. Forced convection is provided by a proprietary blower system.
- Each zone utilizes BTU's *Porcupine II heating element*. This element features a low mass, high surface area open coil wire arrangement for fast response time and high reliability.
- Zones 1, 2, 7 and 8 employ *5-kilowatt* heating elements top and bottom. Zones 3, 4, 5 and 6 employ *2,7 kilowatt* heating elements top and bottom. 5-kilowatt heating elements are available for all zones as an option.
- Oven loading capability is 10 kg/m² based on a nominal conveyor speed of 80 cm/min. With optional 5kW heaters in all zones the loading capacity increases to 15 kg/m².
- The process chamber is a clamshell design and includes the capability to process large format printed circuit boards up to 457 mm wide. 610 mm width board capability is available as an option
- Cross belt temperature uniformity is within a +/- 2°C delta T in the reflow zone (using standard BTU uniformity test board).
- Zone to zone temperature isolation is greater than 60°C.
- Access to the process chamber is accomplished via Powered Hood Lift actuators.

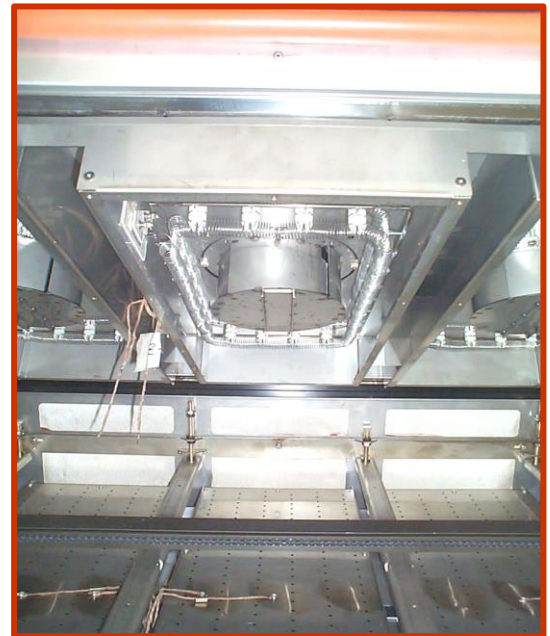
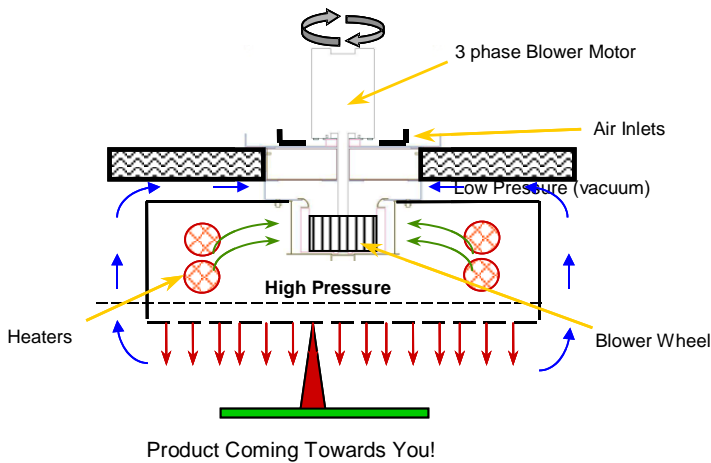

Cooling Section

- Cooling is accomplished via fans with forced convection.
- Closed loop cooling control is available as an option.

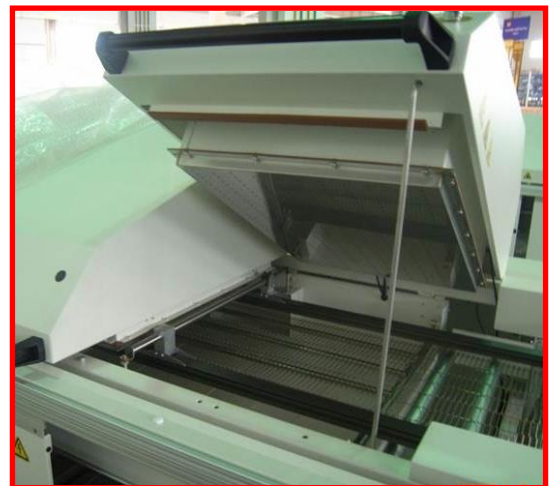
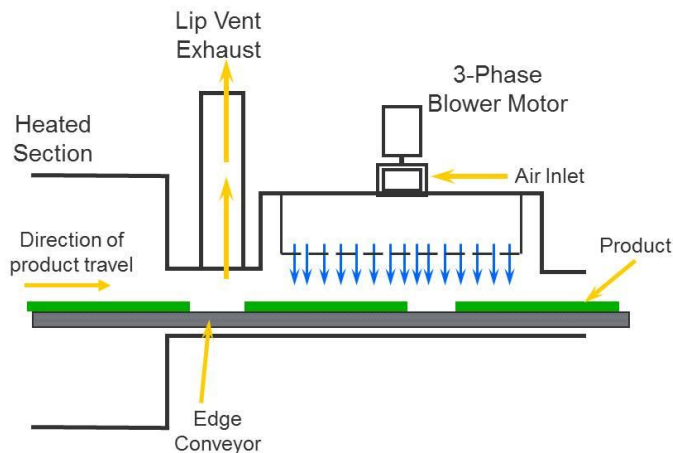

D. Conveyor System

Conveyor Belt	
Belt Width	457 mm
Material	302 Stainless Steel Flat Flex
Conveyor Speed Range	25,4 – 152,4 cm/min.
Conveyor Speed Nominal	80 cm/min.
Product Clearance	51 mm (76 mm optional)
Drive Motor	1/16 hp / brushless DC
Conveyor Height from floor	839 – 991 mm
Rail Edge Conveyor (optional)	
Material	#35 steel roller chain
Width	51 – 457 mm
Support pin length	4,75 mm (std) Others available upon request (optional)
Pin to pin distance	9,5 mm
Support pin height (clearances)	30,5 mm above pin 20,3 mm below pin
Rail parallelism	+/- 0,5 mm
Rail height from floor	859 mm – 1011 mm

- Programmable (recipe controlled) width adjust is included with the *optional* rail edge conveyor.
- Programmable multi-port lubricator is included with the *optional* rail edge conveyor.
- Belt deviation detection via programmable deviation alarm.
- Belt “Stopped” alarm is standard with over torque protection provided via slip clutch.
- Alarm and motion messaging via WINCON™.

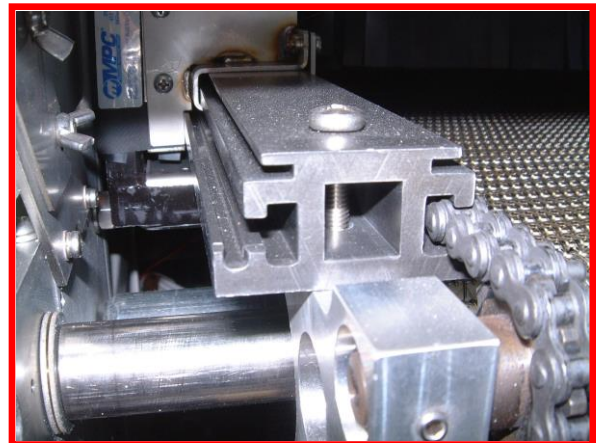
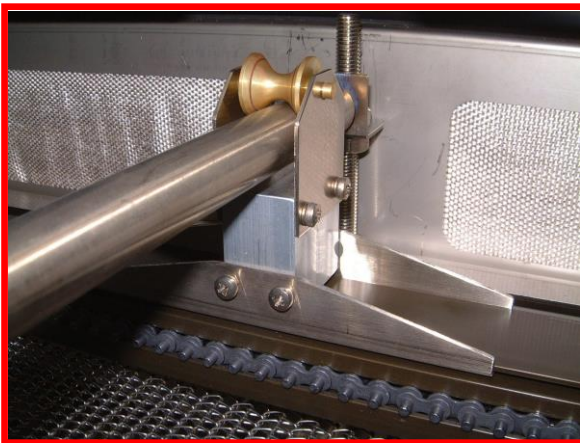

E. Oven Controls

Temperature Control

- Temperature control is accomplished by sixteen (16) PID control loops of the Oven Control Unit (microprocessor) and Windows™ WINCON™ operating software. Each zone is divided into independent top and bottom control. Temperature control accuracy is +/- 0,5°C no-load.
- Optional Cooling control is accomplished by varying blower speed. Cooling rate control is selected via WINCON™ software allowing the user to select the cooling rate.
- Process over temperature protection is accomplished via WINCON™ software using programmable alarm limits. Power to the heaters is removed if the temperature exceeds the high alarm limit.
- *Redundant independent electronic over temperature protection* is standard. In the event of an over-temperature condition, power to the heaters is removed and audible/visual alarm activates. The conveyor continues to operate in this condition.

Operator Interface

- Controls are located on the **RIGHT HAND SIDE** as viewed from the oven entrance.
- The computer keyboard and flat panel display are located at the entrance front of the oven.
- Programming is accomplished via BTU's WINCON software. WINCON operates on the Windows™ 7 platform.
- Thermal profiling can be accomplished using the three dedicated thermocouple inputs located at the oven entrance. BTU is compatible with *KIC and ECD* as an integrated software solution.
- Four (4) Emergency power off buttons are provided, two (2) are located at the loading and two (2) at the unloading sections.
- A three color light tower to monitor the oven status is standard. Indicators are Red – Alarm condition, Yellow – Set-up or Alert condition and Green – Ready Condition.
- Smart Tracker provides an entrance and exit photocell, which senses product entering and exiting the oven. This allows the system to count products for a given recipe, detect product drop/lost and display a graphical view of the products. In the event of a product drop, an alarm will sound.
- Smart Tracker also manages the oven SMEMA ready/busy logic for up and downstream communications to other equipment in the assembly line.
- Automatic shutdown sequencing is standard.

F. Atmosphere System

- The atmosphere system allows for operation in air.

G. Lead-Free Soldering

All Pyramax reflow solder ovens are Lead Free compatible as standard. The Pyramax's high efficiency heat transfer characteristics provide more than sufficient scope to process all popular lead free pastes. BTU's experience in high temperature furnaces has proved invaluable in developing the optimum engineering technology to ensure that both materials used and design parameters are compatible with robust and continuous production at elevated soldering temperatures.

To provide enhanced process control BTU have developed the unique (optional) features: - Open Loop Blower Speed Control and Closed Loop Blower Speed Control. These options, developed for applications such as flip chip, BGA, CSP, 0201, 01005, lead-free, etc... provide programmable convection control continuously monitoring and controlling convection rates in individual sections of the process chamber enabling tighter process windows to be maintained.

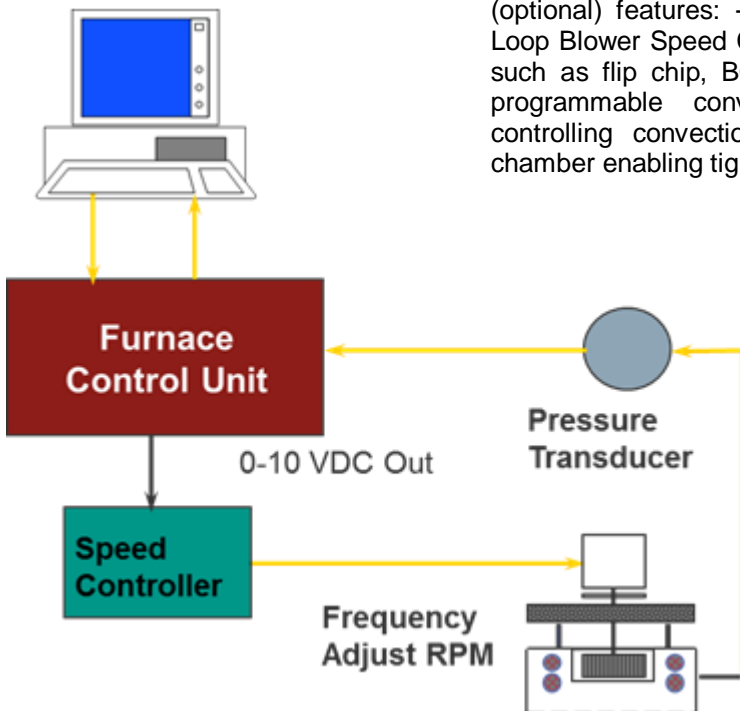

H. Utility Requirements (Electrical power based on std. Heater configuration. See Installation drawing for final power). Other voltage requirements available on demand.

Voltage	Startup Power	Operating Power
380/220 3Ø / 4 wire	54 kW	14-17 kW
400/230 3Ø / 4 wire	59 kW	14-17 kW
415/240 3Ø / 4 wire	65 kW	14-17 kW
Utility	Supply Pressure	Maximum Flow Rate
Exhaust Entrance	0,1 – 0,05 iwc	510 m ³ /h (typical 300)
Exhaust Exit	0,1 – 0,05 iwc	510 m ³ /h (typical 470)

(NOTE: Consult final installation drawing for precise specifications. This is to be used a guide)

- Electrical values are estimated. Actual startup power may vary depending on oven configuration. Operating power is typical and dependent on product loading. Soft start power limiting is possible via WINCON™ software and should be specified at time of order.

I. Physical Characteristics

- Standard Color: Pillar White
- Dry Weight: 1.635 kg
- Shipping Weight: Skid: 1.840 kg
Crate: 2.095 kg

J. Documentation

- System includes BTU's electronic documentation package, which is shipped on the oven PC and on Compact Disc. The package includes:
 - User Documentation
 - Maintenance Documentation
 - Troubleshooting and Repair Documentation
 - 1 Hard Copy manual

K. CE MARK

The furnace complies with following CE standards and directives:

EN ISO 12100-1:	2009	Safety of machinery - Part 1 Basic concept, terminology, methodology.
EN ISO 12100-2:	2009	Safety of machinery - Part 2 Technical principals and specifications.
EN ISO 13857:	2008	Safety of machinery - Distances to prevent danger zones.
EN 349:	2008	Safety of machinery - Minimum gaps to avoid crushing.
EN ISO 13850:	2008	Safety of machinery - Emergency Stop functions.
EN 60204-1:	2009	Safety of machinery - Electrical equipment of machines.
EN 61000-6-4:	2007	Electromagnetic compatibility - Generic emission standard.
EN 61000-6-2:	2005	Electromagnetic compatibility - Generic immunity standard.
EN 55011:	2010	Limits and methods of measurement of radio disturbance characteristics of industrial equipment.

Following the provisions of Directives:

2006/95/EEC Low Voltage Directive (replaced 73/23/EEC)

2004/108/EC EMC Directive (replaced 89/336/EEC)

2006/42/EC Machinery Directive (replaced 98/37/EC)

CE plate is applied and CE certificate is included.